

LED PILOT LAMP

» Product Selection

H□22-□ □

1 2 3

1. SERIES

HPL22 Round Head

HLD22 Flush Head

2.CAP COLOR

R RED

G GREEN

Y YELLOW

S BLUE

W WHITE

3.LED BULB VOLTAGE

HPL22

A AC.DC 24V

E AC.DC 110-120V

I AC.DC 220-240V

M AC 380-440V

Y AC.DC 12V

HLD22

A AC.DC 24V

E AC.110-120V

I AC. 220-240V

M AC 380-440V

» Operating Characteristics

Actuator Type HPL22 Roud Head Lamp

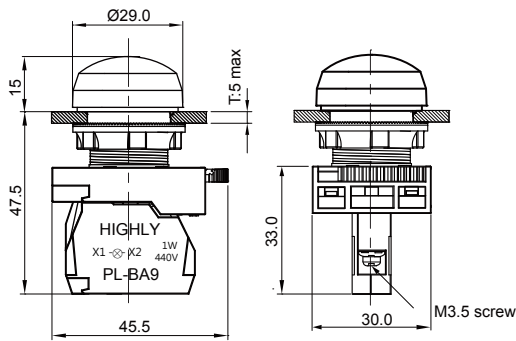

HEAD TYPE	ITEM	CAP COLOR
HPL22: Round Head	HPL22-R□	RED
	HPL22-G□	GREEN
	HPL22-Y□	YELLOW
	HPL22-S□	BLUE
	HPL22-W□	WHITE
	HPL22-O□	ORANGE

Actuator Type HLD22 Flush Head Lamp

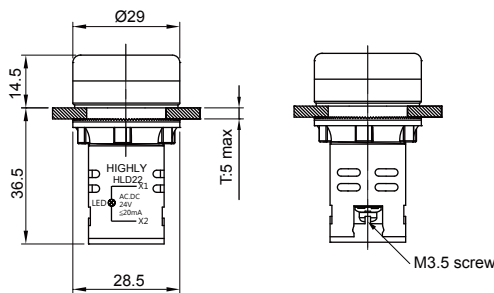

HEAD TYPE	ITEM	CAP COLOR
HLD22: Flush Head	HLD22-R□	RED
	HLD22-G□	GREEN
	HLD22-Y□	YELLOW
	HLD22-S□	BLUE
	HLD22-O□	ORANGE
	HLD22-W□	WHITE

» **Accessories**

CONTACT BLOCKS

CB-□

1

1.CONTACT TYPE

10 1NO

01 1NC

SB Fixing base

A9 Bulb Holder

L Anti-Disturbance Bulb Holder



CB-10

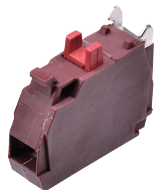

CB-01



CB-SB



CB-A9



CB-L

LED BULB

SB9-□ □

1 2

1.LED COLOR

R RED

G GREEN

Y YELLOW

S BLUE

W WHITE

2.LED BULB VOLTAGE

A AC.DC 24V

E AC.DC 110-120V

I AC.DC 220-240V

M AC 380-440V

Y AC.DC 12V



A.E.I.Y TYPE



M TYPE

BUZZER

HBZ22-□

1

1.VOLTAGE

A AC.DC 24V

E AC.DC 110-120V

I AC.DC 220-240V



MOUNTING ADAPTOR SWITCHABLE

from 22mm to 30mm

HPB30



TOOLS OF FABRICATING

02T

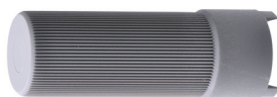

TOOLS OF BULB FABRICATING

T2



HIGHLY

F11

Design, specifications are subject to change without notice.

LED PILOT LAMP

» **Accessories**

PADLOCK COVER

HPB□-□

1 2

1.HOLDER TYPE

22	22mm
30	30mm

2.BUTTON TYPE

H	50mm
E	30mm



HPB22-H06L



HPB30-H06L



HPB22-E06L

ANTI-MISTOUCH COVER

EM□-□

1 2

1TYPE

2.COLOR

Y YELLOW

W WHITE

01

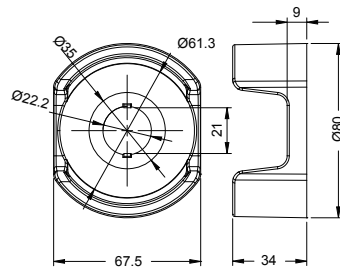

03

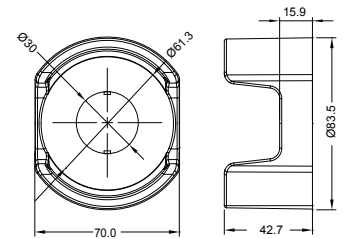

02

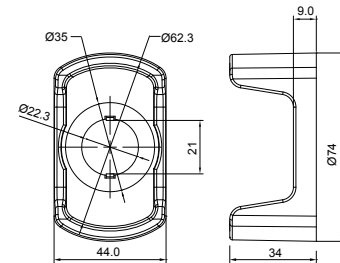

04

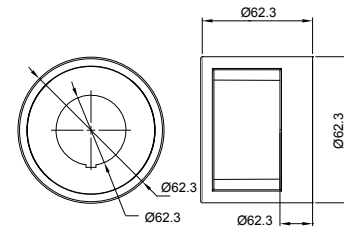
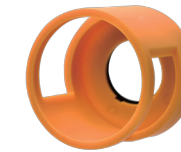

CONTROL BOX

C□-□

1 2

1.CONTROL HOLE Q,T,Y

1	1 holder
2	2 holder
3	3 holder
4	4 holder

2.BOX COLOR

Y YELLOW

W WHITE

